

Oil Miser

By **TÖYÖTÖMI**

Instantaneous Oil-Fired Water Heater

Installation Manual

MODEL **OM-122DW**



IMPORTANT

THIS APPLIANCE SHOULD BE INSTALLED BY A LICENSED, AUTHORIZED PERSON(S) DUE TO THE NECESSITY OF MAKING ELECTRICAL, WATER AND FUEL CONNECTIONS. RETAIN THIS MANUAL FOR FUTURE REFERENCE. CHECK LOCAL CODES AND ORDINANCES FOR PERMITTED USE.

CAUTION

THIS WATER HEATER SHALL NOT BE USED FOR COMMERCIAL USE OR FOR ANY PURPOSES OTHER THAN HOT WATER SUPPLY USES. OTHER USAGE MAY CAUSE A MALFUNCTION OR SHORTEN ITS SERVICE LIFE. DO NOT REMOVE THE RATING PLATE AND LABELS FROM THE WATER HEATER UNIT.

CONTENTS

SECTION A:	Temperature and Pressure Relief	
Safety Tips for Installation	Valve Installation	6
	Permanent Wiring Installation	6
SECTION B:	Plumbing	7
Unpacking	Installation of Unit and Flue Pipe	9
Standard Installation Parts		
Accessory Parts	SECTION D:	
Dimensional Outline	Test Run	
	Preparation	12
SECTION C:	Operation	12
Installation		
Selecting a Location	SECTION E:	
Tools Needed for Installation	Chimney Installation	13
Fuel Tank Installation		
Removing Air Trap		

SECTION A: SAFETY TIPS FOR INSTALLATION

BE SURE TO FOLLOW THE FOLLOWING INSTRUCTIONS.

The instructions which are contained in this manual are classified into the following two types, which are "WARNING" and "CAUTION". These instructions are intended to provide important information for safe operation.

"WARNING" indicates the possibility of causing the user a fatal accident or serious injury if the water heater is incorrectly operated.

"CAUTION" indicates the possibility of causing the user injuries or material damages if the water heater is incorrectly operated.

WARNING

1. Never use any fuel other than ASTM (AMERICAN SOCIETY FOR TESTING AND MATERIAL) D3699 1-K Kerosene, D396 Low Sulfur No. 1 or No. 2 Fuel Oil, or ASTM D975 Ultra Low Sulfur Diesel (ULSD). You are recommended to use the low sulfur fuel.
NEVER USE GASOLINE! Use of such fuels can result in an explosion and/or fire and cause injury.
2. Improper installation, adjustment, modification, or service and maintenance by an unauthorized person may cause **SERIOUS UNIT DAMAGE, BODILY INJURY, HAZARD OR PROPERTY DAMAGE**. This unit should be installed by a licensed, authorized person(s) due to the necessity of making electrical, water and fuel connections. Refer to the installation manual and the operation and maintenance instructions for assistance, or consult your dealer for further information.
3. **HAZARD OF ELECTRICAL SHOCK!** Before removing any access panels of water heater for service, make sure the electrical supply to the water heater is shut off. Failure to do this may result in **HAZARD, SERIOUS BODILY INJURY, OR PROPERTY DAMAGE**.
4. Check and comply with all local, state and ANSI Z21.22 codes that may apply to water heater(s) before beginning the installation.
5. This water heater is designed to be used no more than 4,922 FT. (1,500 m) above sea level. When the water heater is installed with the flue pipe at altitude of higher than 1,640 FT. (500 m) ~ 4,922 FT. (1,500 m) above sea level or is installed with the chimney adapter at altitude of higher than 3,280 FT. (1,000 m) ~ 4,922 FT. (1,500 m), adjustments are needed.
Ask your local dealer.
The water heater may have a failure of combustion at a high altitude.
6. **RISK OF INDOOR AIR POLLUTION AND FIRE.** Be sure the exhaust pipe is properly installed and connected. Aluminum tape provided may be used for sealing exhaust pipe connections.

CAUTION

1. Keep the area around the unit clean and free of flammable materials.
2. **RISK OF FIRE AND ELECTRIC SHOCK.** Do not apply any excessive force or pressure to the power supply cord. Make sure the plug is free of dust. Be sure plug fits the receptacle securely.
3. Install a temperature and pressure relief valve on the installation mouth in accordance with local, state and ANSI Z21.22 codes. See the page 6 for more details.
4. When No. 2 fuel oil is used in an area where the temperature becomes less than 25°F (-4°C), it is recommended the use of an additive with the fuel to prevent congealing. Check with a fuel supply company for the proper additive and mix.

DIMENSIONAL OUTLINE

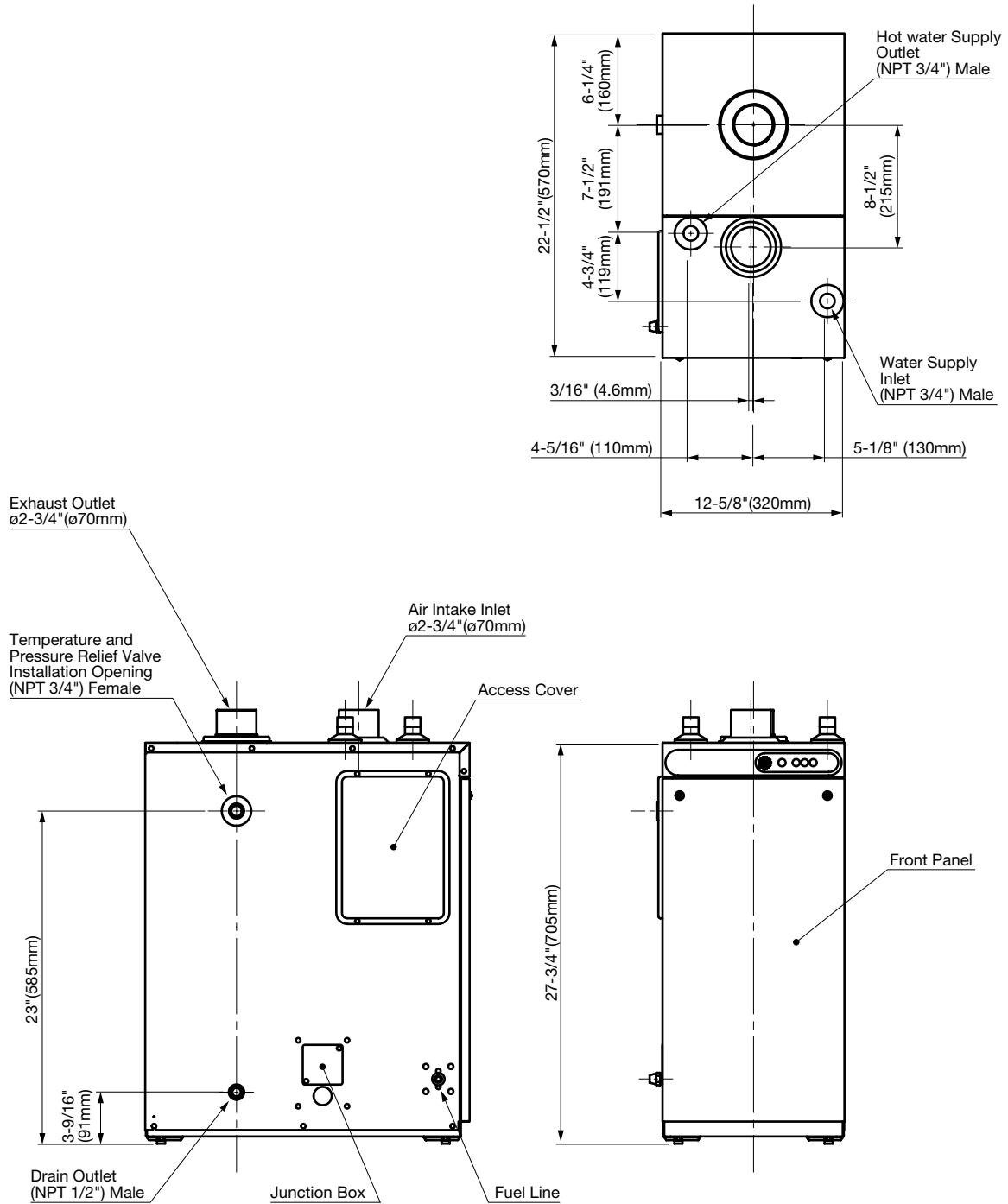

SECTION C: INSTALLATION

WARNING: This unit must be installed in accordance with these instructions, local codes, ordinances and/or in the absence of local codes, the latest edition of the national fire protection association (NFPA31) code.

Check and comply with all state, local codes and ANSI (AMERICAN NATIONAL STANDARD INSTITUTE) Z21.22 that may apply to water heater(s) before beginning the installation.

This unit should be installed by a licensed, authorized person(s) due to the necessity of making electrical, water and fuel connections.

SELECTING A LOCATION

CAUTION: When No. 2 fuel oil is used in an area where the temperature becomes less than 25°F (-4°C), it is recommended the use of an additive with the fuel to prevent congealing. Check with a fuel supply company for the proper additive and mix.

Select a place to install the water heater where water and electric supply are easily available.

1. Select a place which is free of moisture, water spills, pools or snow.
2. Select a place which draining can be done easily.
3. Select a place which the fuel tank can be installed safely.
4. Select a place which is free of combustible substances.
5. The surrounding walls should be finished with noncombustible materials (concrete block, mortar, or plaster are acceptable).
6. The floor on which the water heater is installed must prevent intensive vibrations or shock and must be strong enough to bear the weight of the water heater.
7. Select a place where proper maintenance and repair can be provided for the unit after installation.
8. Select a place sheltered from weather.
9. Install the unit on a noncombustible surface in a stable position. If installing on combustible floor, the unit should be raised off the floor to prevent contact with combustible materials.
10. Select a place with a suitable environment, which is non-corrosive or non-toxic.
11. The flue pipe is free of snow, icing, leaves, bird's nest or strong drafts.
12. Before making a hole in your wall for the flue pipe, make sure the area is free of electrical wires, gas pipes and other obstacles.

TOOLS NEEDED FOR INSTALLATION.

Tool	Use
Phillips Head Screwdriver	Installation of flue pipe, etc.
Electric Drill	Drilling hole in wall for flue pipe
Hole Saw, 4-3/4" diameter	Making hole in wall for flue pipe
Pipe Wrench	Connecting fuel pipe

FUEL TANK INSTALLATION

The fuel tank must be purchased separately and installed by a qualified fuel supply technician.

NOTE: Fuel tank installation must comply with National Fire Protection Association Code NFPA 31 or locally applicable codes. Check with local building officials.

The following instructions should be followed for installation of a large capacity, gravity-fed fuel tank.

- Installation height of tank's fuel outlet should be at least 12 in. above floor surface upon which the water heater rests.
- To avoid excess fuel pressure to water heater, the top of fuel tank should be no more than 8-1/2 ft. above the bottom of the unit.
- The inlet fuel pressure must not exceed 2.5 PSI. If the inlet pressure exceeds 2.5 PSI, a pressure reducer (Part #10005099) must be used.
- Fuel tank should be located at least 6 ft. away from all heat sources.
- 3/8" OD copper tubing should be used for the fuel line.
- To prevent air locks in the fuel line, the fuel line should be smooth with no inverted U-shaped line or sharp bends.
- Install a UL listed fuel filter at the fuel tank outlet. Shut-off valves should also be installed on the fuel line and connected to the tank as shown below. Unit should have a separate fuel line from fuel tank.

NOTE: An additional shut-off valve installed next to the exterior wall will minimize the amount of fuel to be drained should the water heater need to be disconnected. If the valve is inside the building, a fusible link type (Part #10005597) is recommended.

1. All external tank must be vented.

2. Install a UL listed fuel filter at the fuel tank outlet.

Specifications required of this fuel filter are as follows:

Type of Fuel: ASTM D3699 1-K Kerosene, ASTM D396 Low Sulfur No.1 or No.2 Fuel Oil, or ASTM D975 Ultra Low Sulfur Diesel (ULSD).

Rated Filtering Capacity: 2 GPH (Minimum)

3. The fuel supply tank must be positioned as to allow gravity feed to the unit and high enough to reduce trapped air in the fuel line. Please refer to Section "D", page 8 in the Operation and Maintenance Instructions for the procedure to remove trapped air. (*)

NOTE: If the maximum height is exceeded, a fuel pressure limiting valve is required. Part No. 10005099 has 3/8 in. (N.P.T.) inlet and outlet female opening to accept the fuel line fittings.

NOTE: Fusible Link Valve (#10005597)

- It is most important that the valve, depending on its use, be fully opened or fully closed.
- The top nut on the valve (below the turn handle) is sealed and should never be tightened or removed.
- When installing fuel lines to the valve, be sure to check for fuel leakage.
- A LEAKING VALVE SHOULD ALWAYS BE REPLACED.

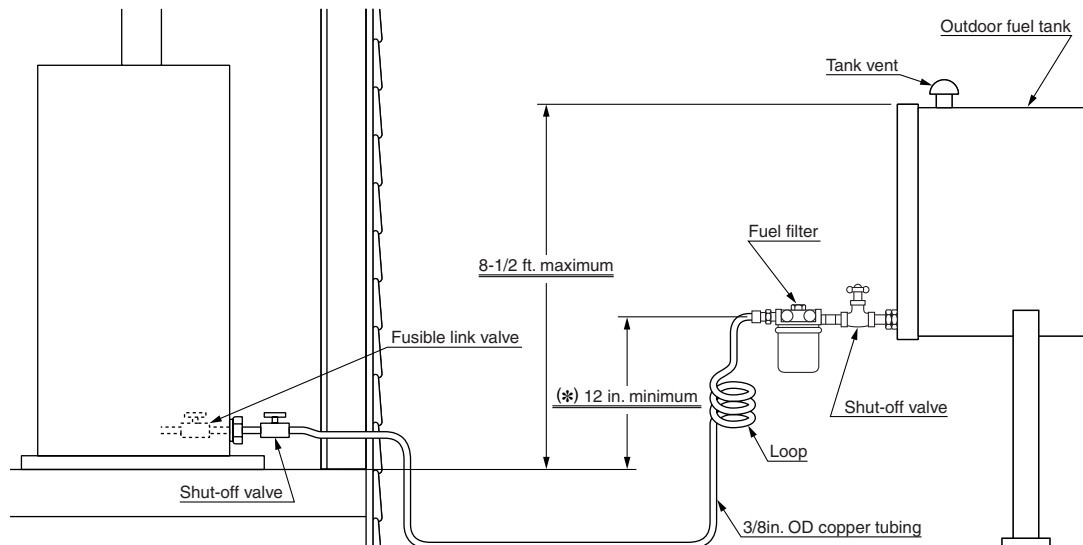

REMOVING AIR TRAP

When operating for the first time or when refueling an empty tank, air may be trapped in the fuel line, making ignition difficult. In this situation, after removing the trapped air thoroughly from the fuel filter at the fuel tank outlet, follow the procedures below:

1. Press "POWER SWITCH" to "OFF" position. Disconnect the power supply cord.
2. To catch the fuel which will drain out, put a small container under the strainer.
3. Loosen the screw on top of the strainer. Immediately wipe off any spilled fuel.
4. Remove the trapped air thoroughly. Failure to remove all the air will cause improper ignition and may extinguish the unit.
5. Tighten the screw after removing trapped air.
6. Plug into the receptacle. Press "POWER SWITCH" to "ON" position.

NOTE: In the event of an ignition failure, press "POWER SWITCH" to "OFF" position and after 10 seconds press "POWER SWITCH" to "ON" position once again.

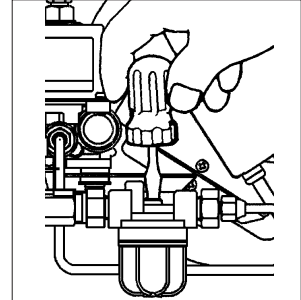

TEMPERATURE AND PRESSURE RELIEF VALVE INSTALLATION

At the time of installation, a temperature and pressure relief valve complying with the standard for Relief valve for Hot Water Supply System, ANSI, shall be installed in the threaded opening provided on the water heater for the temperature and pressure relief valve. Local codes should govern the installation of the relief devices.

Specifications required of this temperature and pressure relief valve are as follows:

Inlet (male): 3/4 in.
Temperature relief: 210°F
Pressure relief setting: 150PSI
Rated capacity: Min. 148,000 BTU/H

- (a) No other valve is placed between the relief valve and the water heater.
- (b) Discharge from the relief device is routed to a suitable place for disposal when relief occurs.
- (c) No reducing coupling or other restrictions are installed in discharge line.
- (d) Discharge line is installed to allow complete drainage for the device and line.

Note: Manual operation of pressure relief valves should be done at least once a year.

PERMANENT WIRING INSTALLATION

WARNING: RISK OF FIRE AND ELECTRIC SHOCK. Make sure the power supply cord is disconnected to avoid any electric shock before servicing. Electric shock may cause serious injury. It is recommended that installation should be conducted by a licensed electrician.

BE SURE TO FOLLOW THE FOLLOWING PROCEDURE

POWER SOURCE: 120V AC, 60Hz single phase

1. Disconnect power supply cord from power source.
2. Remove four (4) screws and junction box cover on the left side of unit.
3. Disconnect ground wire (green) from the power supply cord bracket.
4. Disconnect two power supply wires from upper side of the terminal.
5. Squeeze strain relief with the adjustable pliers to remove plastic bushing from the unit. Remove the power supply cord.
6. Replace the strain relief bushing to the power supply cable and insert the cable into the hole of the left side of unit. Connect the ground wire to the power supply cord bracket and power wires to the terminal.
7. Affix the junction box cover to the unit and insert screws.
8. Electrical connections should conform to proper electrical methods, and in conformance with local codes or regulations. A licensed electrician familiar with local codes and ordinances should make the necessary connections.

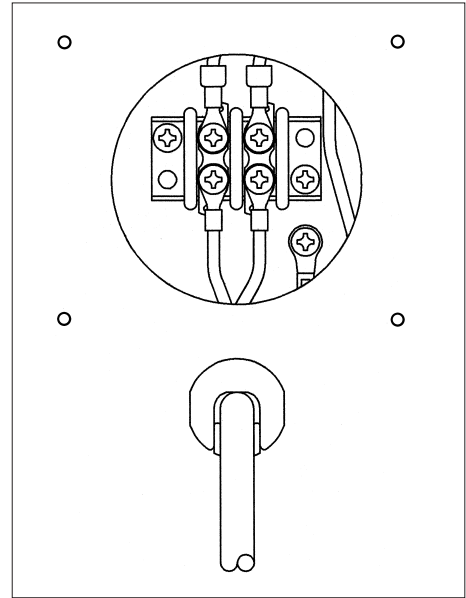

PLUMBING

COLD AND HOT WATER PLUMBING

WARNING: Plumbing should conform to proper plumbing methods, and in conformance with local codes or regulations.

A licensed plumber familiar with local codes and ordinances should install the OM-148.

CAUTION: An ANSI listed temperature and pressure relief valve should be installed at the hot water outlet connection of the heater at the time of installation. Local codes should govern the installation of the relief devices. See page 6 for a temperature and pressure relief valve specifications.

If a check valve or one-way valve is required on the cold water supply line, it is recommended that an expansion tank (100 psi, 8 gal Min.) should be installed on the hot water supply line.

When the unit is to be installed as a replacement water heater, it is important to determine whether a check valve has been installed or not.

Remove the check valve before installation of the unit unless a check valve is required by local code.

In order to prevent the water heater from being damaged or developing a leak, regardless of being used in a cold, warm or hot region, the cold water supply piping, hot water supply piping, drain pipe, check valve, valves, expansion tank, and temperature and pressure relief valve should be protected with sufficient insulation materials (by wrapping with heat insulation or by equipping with a freeze prevention heater).

1. A water softener is recommended in regions where hard water may be a concern.
2. Use the following water quality.

Description	pH	Chloride	Hardness	Residual Chlorine
Maximum Levels	6.5 to 8.5	0.0067 Oz/gal. (50 mg/L)	0.0208 Oz/gal. (150 mg/L)	0.00027 Oz/gal. (2 mg/L)

3. Do not apply any heat to the unit nipples.

4. Use standard copper alloy unions and nipples for the connections to the unit.
5. Copper piping is recommended for the hot water supply line.
Note: Refer to local codes when considering piping materials. Steel piping is not recommended as it may cause rust in the piping. Use NPT for piping of hot and cold water.
6. Connecting plumbing to the unit, hold unit fittings securely with a wrench to prevent damage to the unit.
7. Installation of a water filter is recommended.
8. The distance between the water heater and places where hot water is used should be as short and direct as possible, and a uniform pipe size of sufficient diameter to carry the full capacity of hot water should be used.
9. Be sure to connect the water inlet and the hot water outlet as shown on the water heater. Reversing the two connections will damage the unit.
10. When hot water flows through the supply line there is an inevitable heat loss, regardless of type of water heater. Thus, insulation or protection of hot water piping is encouraged.
11. Flush the piping before connecting to the unit.

Plumbing Example

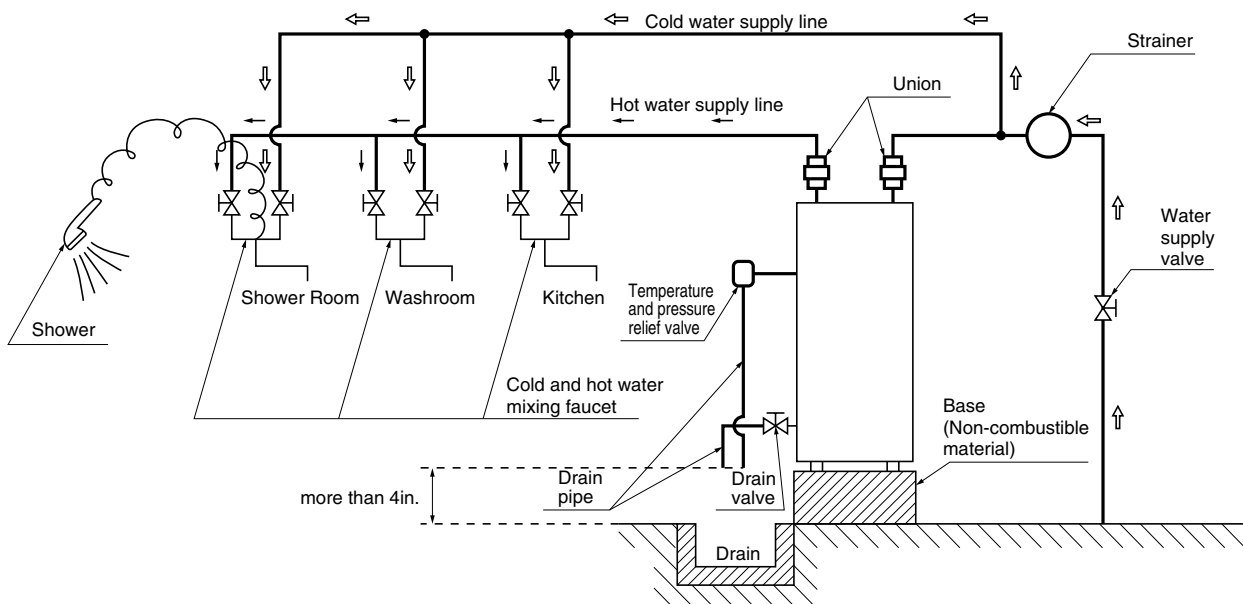

- CAUTION:**
- Do not allow pipes or valve to freeze.
 - Refer to PREVENTING FREEZE UP on Page 10 of the instruction manual.
 - Do not use the unit as an auxiliary heat source for a solar hot water heater, nor hydronic heating.

INSTALLATION OF THE UNIT AND FLUE PIPE

SAFETY TIPS

WARNING:

1. The flue pipe opening must be fully exposed to outside air. Do not vent into a garage, basement, under the floor, or into any enclosed area.
2. Do not install the flue pipe in close proximity to other objects or materials.
3. Before making a hole in your wall for the flue pipe, make sure the area is free of electrical wires, gas pipes and other obstacles.
4. Do not install the flue pipe where it will be exposed to heavy snow, collected leaves, or strong winds.

IMPORTANT: In areas of heavy snow fall, ground surface clearance must be increased according to average snow falls.

In open areas with strong wind, a wind breaker may be necessary.

5. Do not install the flue pipe below the water heater.
6. The exhaust pipe should be properly installed and connected. Aluminum tape may be used for sealing exhaust pipe connections.
7. Always cover the exhaust pipe with the insulating cloth cover.
8. If installed in building without an eave, a non-combustion eave should be installed directly above flue pipe.

CAUTION:

Total length of the extension pipe between the water heater and the flue pipe must be no greater than 10 ft. with a total of three bends.

NOTE: When using extension pipes always cover the exhaust pipe with the insulating cloth cover.

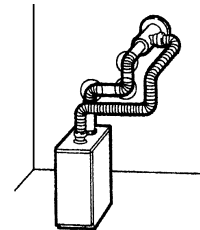

INSTALLATION OF UNIT

1. Install the unit on a noncombustible surface in a stable position. If installing on a combustible floor, the unit should be raised up off the floor to prevent contact with combustible materials by using brick, concrete block or similar non-combustible material. If minimum clearances between the unit and combustible construction are maintained, no ventilation openings are needed in the closet door when installed in a closet.

• UNIT (INDOOR CLEARANCE)

Left side	6 in. (150 mm)
Right side	6 in. (150 mm)
Rear side	6 in. (150 mm)
Front	2 ft. (600 mm)
From front door to closet	6 in. (150 mm)
Top	2 ft. (600 mm)

- If the combustible material is protected with non-combustible material such as 0.024 (24-gage) sheet metal with ventilated air space, the following clearance is applied.

Left side	2 in. (50 mm)
Right side	2 in. (50 mm)
Rear side	2 in. (50 mm)

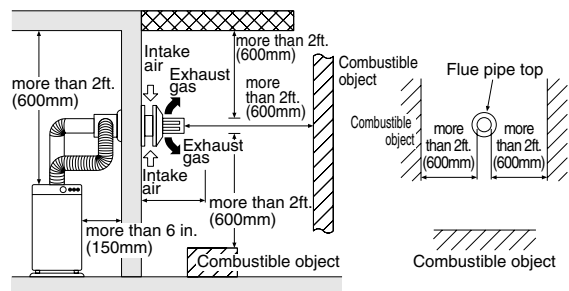

NOTE: It is important to keep enough clearance for the purpose of maintenance, repair and possible servicing. We recommend the following clearance for servicing.

Left side	2 ft. (600 mm)
Front	5 ft. (1.5 m)

• FLUE PIPE (OUTSIDE CLEARANCE)

From flue pipe top to combustible surface: Vertical	24 in. (600 mm)
From flue pipe top to combustible surface: Horizontal	24 in. (600 mm)

• EXTENSION EXHAUST PIPE (WITH INSULATING CLOTH)

From extension exhaust pipe to combustible surface: Vertical	3 in. (76 mm)
From extension exhaust pipe to combustible surface: Horizontal	3 in. (76 mm)

2. Check local codes regarding installation of the water heater, water piping and fuel tank.

INSTALLATION OF FLUE PIPE

IMPORTANT: Check and comply with all state and local codes that may apply to water heater before beginning installation.

1. Select unit location. Allow clearances as indicated above between the unit and all other materials
2. Make sure that the outside area to where the flue pipe will reach is clear of any objects.
NOTE: For wall thickness greater than 10-1/2 inches, a flue pipe extension is available. See page 2 for details. Flue pipe can be installed through any standard building materials.
3. For standard installation, position the hole for the flue pipe. (See diagram on page 12.)
NOTE: The water heater should be installed on a sturdy floor that is level and flat.
4. Cut the hole for the flue pipe from inside the room. Use a 4-3/4" diameter hole saw attached to an electric drill. The opening on the inside wall should be slightly higher than the outside opening (approximately 1/4") so that the flue pipe will slope slightly downward (approximately 3 degrees) after it is installed. This will enable condensed moisture to drain from the flue pipe to the outside and prevent rain or snow from entering from outside after installation.

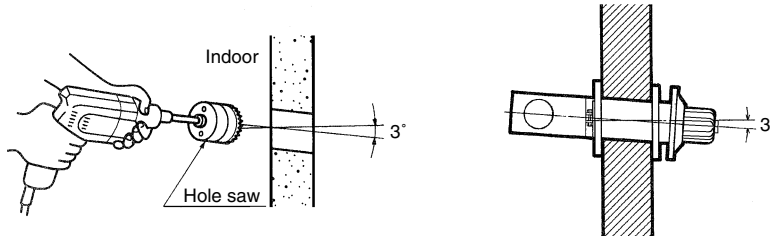

5. Install the inner flange and the flange gasket to the inner flue pipe and insert the inner flue pipe through the wall hole from inside the room. Make sure the arrow on the inner flange is pointing up and secure the securing band with a screw and a nut through two holes of the fixing band. Secure the inner flue pipe to the wall with the four screws provided with the unit.

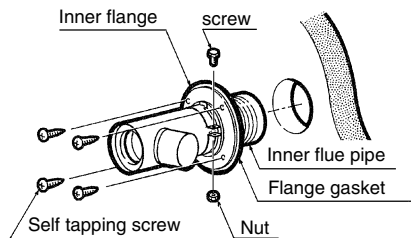

6. Install the flange gasket to the outer flue pipe. Secure the outer flue pipe to the wall by turning it clockwise. Continue turning the outside flue pipe until the inner and outer flanges fit tightly against the inner and outer walls.

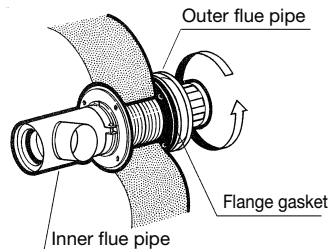

7. Insert the flexible exhaust pipe to the flexible bent joint until it locks. Insert the flexible bent joint to the exhaust opening of the inner flue pipe until it locks.

NOTE: The flexible exhaust pipe and flexible bent joint have claws to prevent them from being separated. When connecting them, raise the claws a little.

These claws may be raised already depending on production lots. If this is the case, insert them as they are. Do not attempt to draw a pipe off in any event while the claw is raised. Otherwise, it could cause a leak of exhaust gas.

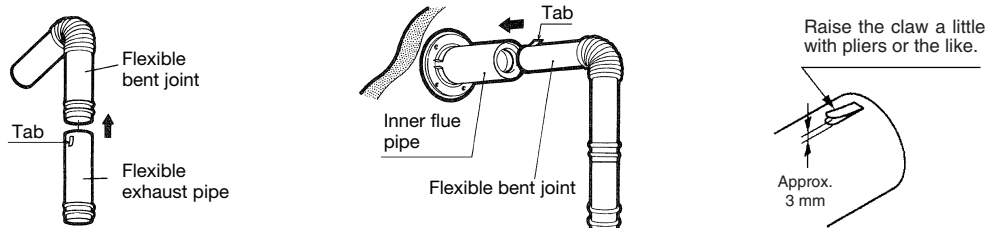

8. Slide the insulating cloth cover over the flexible exhaust pipe and the flexible bent joint.

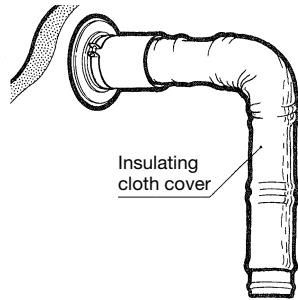

9. Remove the screw from the exhaust opening of the unit. Insert the flexible exhaust pipe to the exhaust opening and secure them with the screw.

NOTE: Seal all connections of the pipes with the aluminum tape.

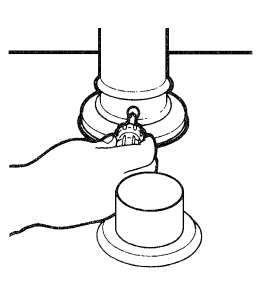

- CAUTION:
- Do not attempt to insert the exhaust pipe forcibly.
 - If O-ring is damaged, it could cause a leak of exhaust gas.
 - If the exhaust pipe is inserted after raising the claw, the pipe is locked in position with the claw so that the pipe will become unable to remove.
 - If it is attempted to remove forcibly, the exhaust pipe may be broken.

10. Connect rubber joints to the both ends of the inlet hose.

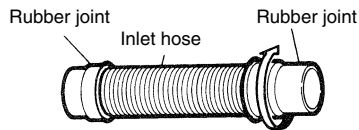

11. Place the hose bands on the rubber joints and attach the hose as shown below. Tighten the bands.

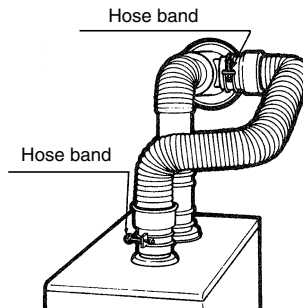

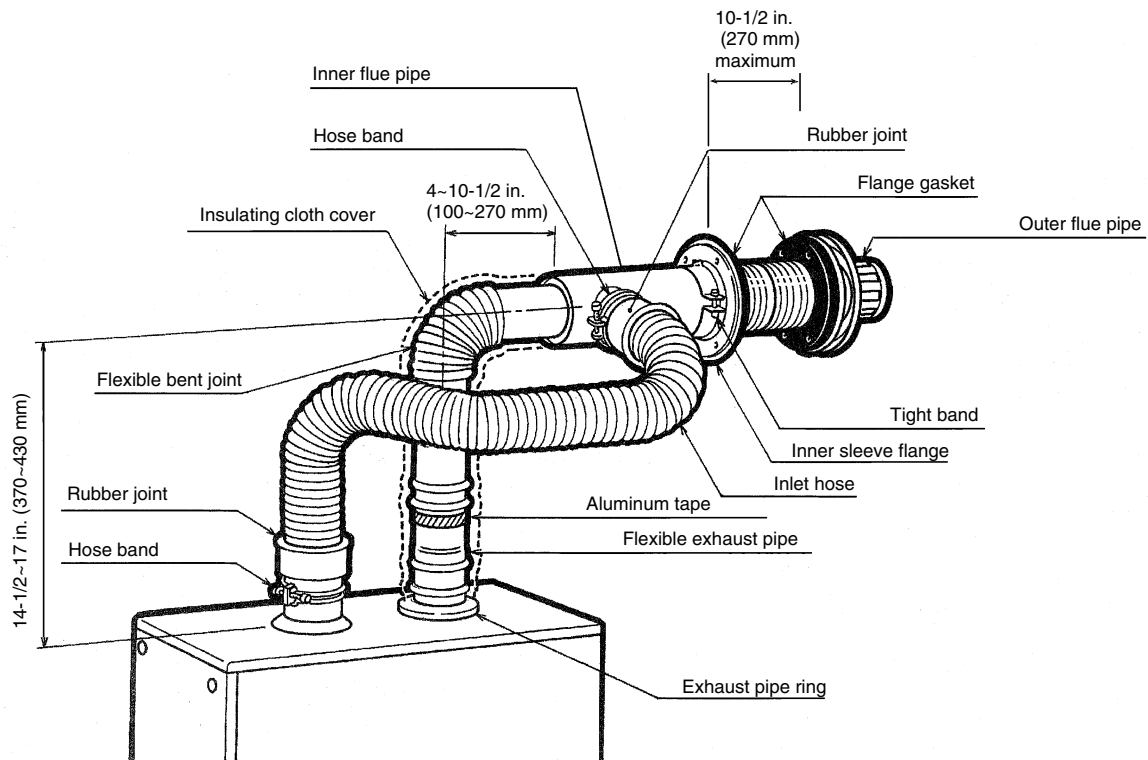

SECTION D: TEST RUN

PREPARATION

1. Make sure the flue pipe is installed properly.
2. Make sure the fuel tank is installed properly. Make sure there is no fuel leakage.
3. Make sure there is no water leaking from piping. (Plumbing)
4. Make sure electrical connections and grounding are wired properly.
5. Make sure the floor is stable and can withstand strong vibration and the weight of a full water heater.
6. Make sure the area is free of flammable materials.
7. Check for air trapped in fuel lines.

OPERATION

1. Open the fuel supply valve.
2. Set the hot water temperature on the control panel.
3. Press the power switch on the control panel to turn on. "Power" lamp goes on.
4. Open hot water faucet and unit will ignite in a few seconds.

SECTION E: CHIMNEY INSTALLATION

This unit is a sealed combustion system and as an installation option it may be connected directly to a chimney. Using this option, room air is used for combustion and the exhaust gases are vented into the chimney to the outside.

IMPORTANT:

1. **This appliance should be installed by a licensed, authorized person(s)** due to necessity of making electrical, water and fuel connections. Check local codes and ordinances and/or the latest edition of the National Fire Protection Association Standard for the Installation of Oil-Burning Equipment. NFPA-31.
2. A **Barometric Draft Regulator** must be used in the exhaust pipe to stabilize flue draft. It is **required** that a **UL-listed (Underwriters Laboratories)** damper be used. The Barometric Draft Regulator must be installed in accordance with NFPA-31.
3. Installation in an **unconfined space** in buildings of conventional frame, brick or stone construction, infiltration normally is adequate to provide air for combustion and ventilation. For **confined spaces**, openings for air intake and venting must be provided. (See Fig.1.) Check local codes and ordinances and/or NFPA-31 Code for specific details.
4. It is recommended that the OM-122DW hot water heater be connected to an independent chimney flue.

CAUTION:

1. In case another appliance is connected to the same chimney flue (2 or more units), it may be necessary to comply with state and local codes.
2. Connecting the OM-122DW hot water heater with two or more appliances using the same chimney flue may affect the performance of the hot water heater.
3. Total length of the exhaust pipe and the chimney liner must be no greater than 25 ft. Maintain the shortest piping possible by selecting a location as close as possible to the chimney.

NOTE:

1. To prevent against exhaust leaks, make sure all connections are properly fitted and seal connection with aluminum tape or heat resistant sealing material.
2. A 5-inch or 4-inch diameter exhaust pipe is used for a chimney installation. To prevent injury due to the hot surface of the exhaust pipe, be sure to wrap the exhaust pipe with a heat insulator material.
3. For a chimney installation, use accessory (option) parts.
Chimney Installation Adapte Kit
(Part #20476430 - Dia.5" or Part #20478415 - Dia.4")

Installation of Chimney Example

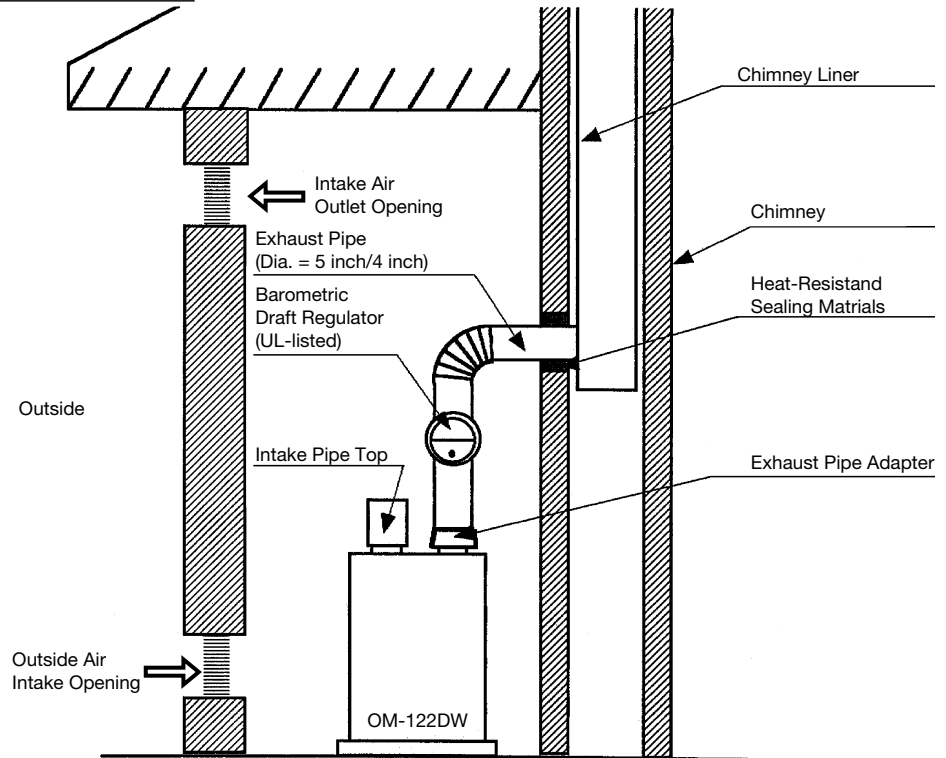

Fig. 1

INSTALLATION OF EXHAUST PIPE ADAPTER

Remove the screw from the exhaust outlet of the unit. Insert the exhaust pipe adapter to the exhaust outlet and secure with the screw.

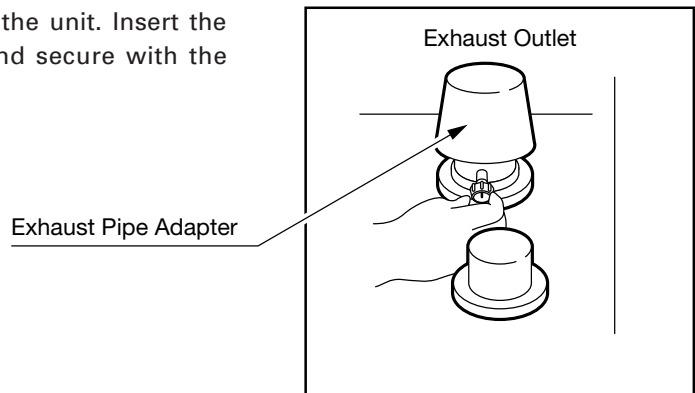

Fig.2

INSTALLATION OF INTAKE PIPE TOP

Insert the intake pipe top to the intake opening of the unit.

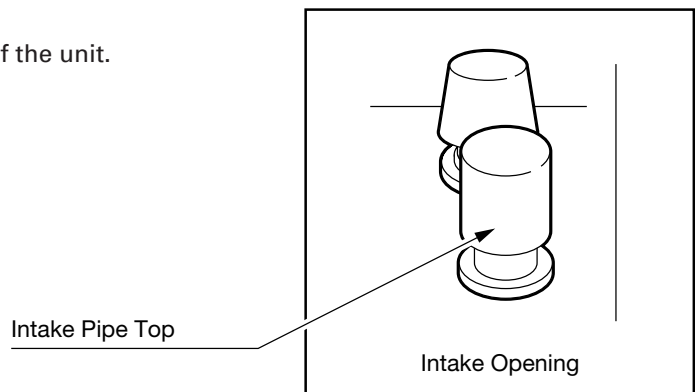

Fig.3

TOYOTOMI U.S.A., INC.

604 Federal Road, Brookfield, CT 06804

www.toyotomiusa.com

This manual supersedes earlier editions. PART No.20476894